

FIND THE DIFFERENCE.

A lot of people did bad things to Joseph.
But he said, **“You planned evil against me;
God planned it for good”**

Genesis 50:20a HCSB©

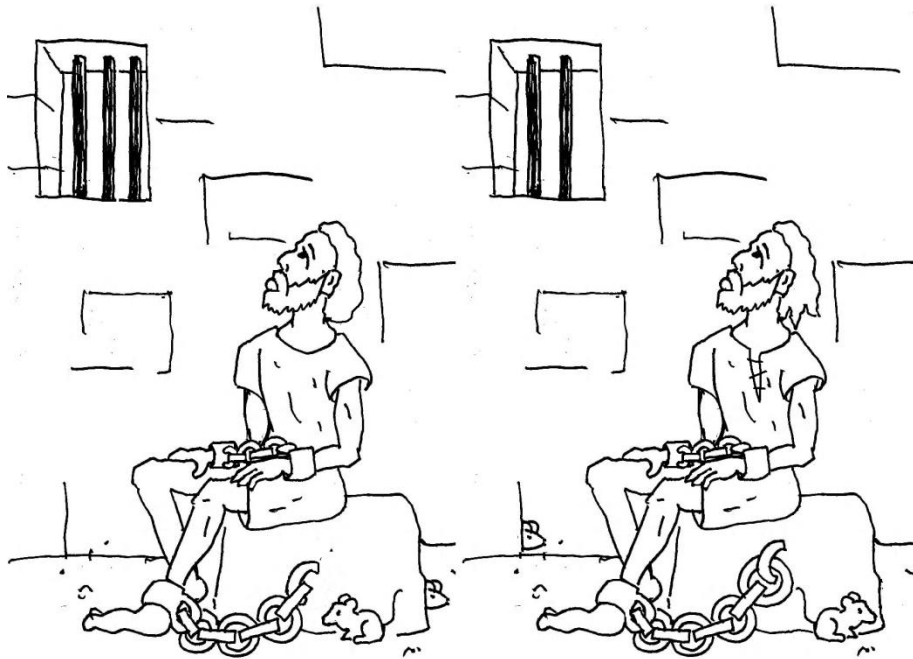

Circle the six differences between the two pictures of Joseph.

Can you read the verse in reverse?

The LORD is on my side; I will not fear.
What can man do to me?

© 2023 118:6 E2V ©



BIBLE TIME FUN WEEKLY

Issue 253



May the
God of hope
fill you with
all joy and
peace as
you trust in
Him...

Romans 15:13a NIV©

coloringpagesbymradron.blogspot.com

Let's talk about it. Why does trust in God give you hope?

Use the word clues to find the words from the verse. Next, copy the marked letters to finish the sentence.

In the past God spoke to our ancestors through the prophets at many times and in various ways, but in these last days He has spoken to us by His Son, whom He appointed heir of all things, and through whom also He made the universe.

Hebrews 1:1-2 NIV©

Built, formed, shaped [] _ _ _ _

Everything, cosmos _ _ _ _ _ []

Seers, priests, forecasters _ _ _ _ _ []

Offspring, heir, boy [] _ _

History, former, "old times" _ [] _ _

By means of, passageway _ _ _ _ _ [] _

Forefather's blood line _ _ _ [] _ _ _ _

Jesus Christ is the _____ of the Bible.

Let's talk about it. How does Jesus show us what God wants?

THE CODEBREAKER

Use the clues to break the code.

© Psalm 34:18 NIV

Clues: =E, =O, =R, =S,

Why is the Lord close to the brokenhearted?

N W T Y O X D W I L L P R
 P D U H S L D F N E C H M
 I S A N C E S T O R S O R
 E R Y C D S R D H V L U E
 G E O E H E G V S E D S L
 L V U L I O S E I M K E A
 U I R P R V O I R N N H M
 L B S N H S G S R K G O O
 O T E H I R S R E A I L R
 R V L Y U L A N D V B D I
 D P V A O H N T W I L L T
 S E E M S N E G E I E T E
 E P S R G O D S N S R A S

Find the Underlined Words.

Joshua 24:15 NIV©

But if serving the Lord seems undesirable to you,
 then choose for yourselves this day whom you
 will serve, whether the gods your ancestors
 served beyond the Euphrates, or the gods of the
Amorites, in whose land you are living. But as for
 me and my household, we will serve the Lord.

If God is always going to win, why serve anybody else?

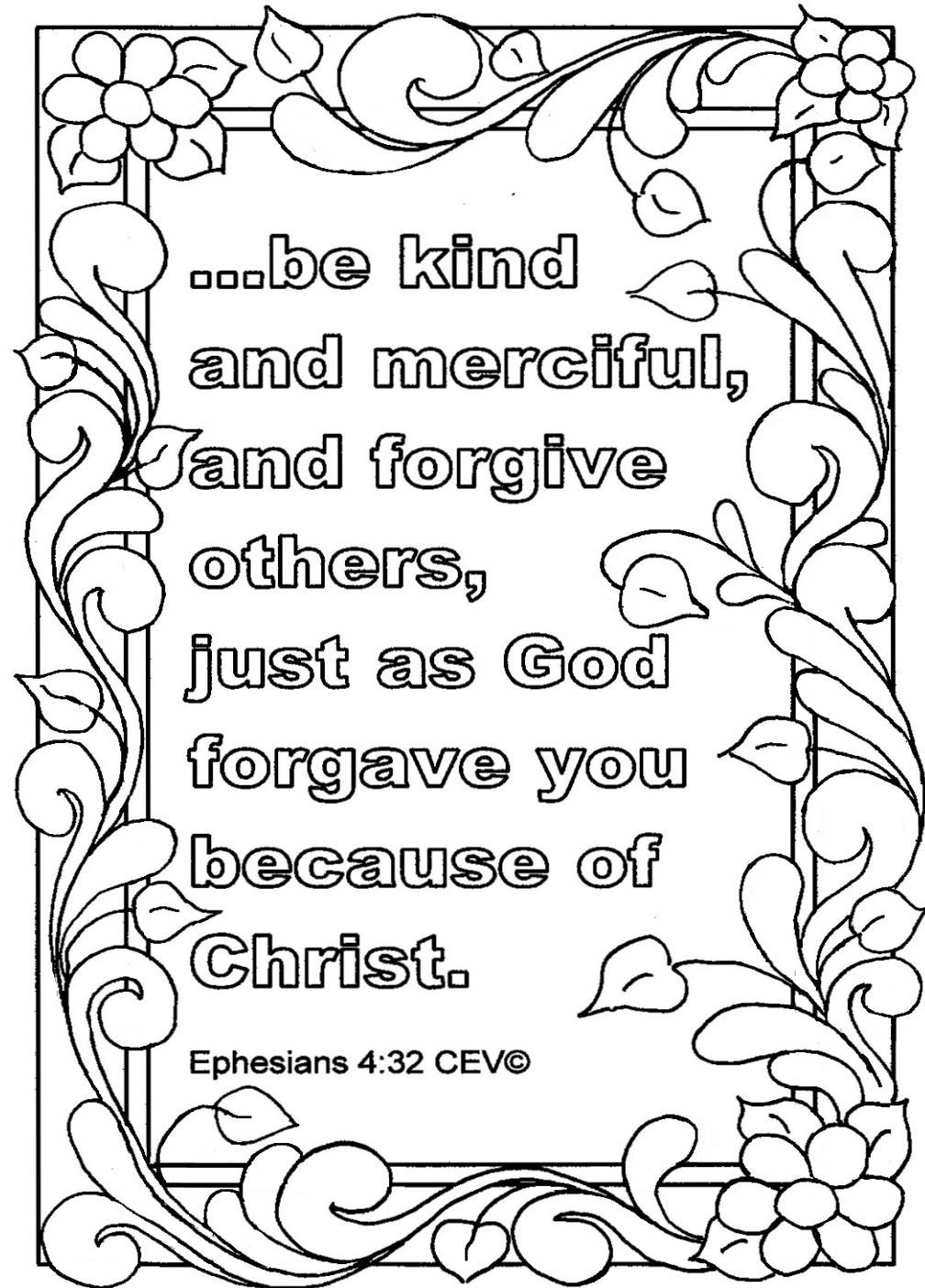

Let's talk about it. What is God's forgiveness like?

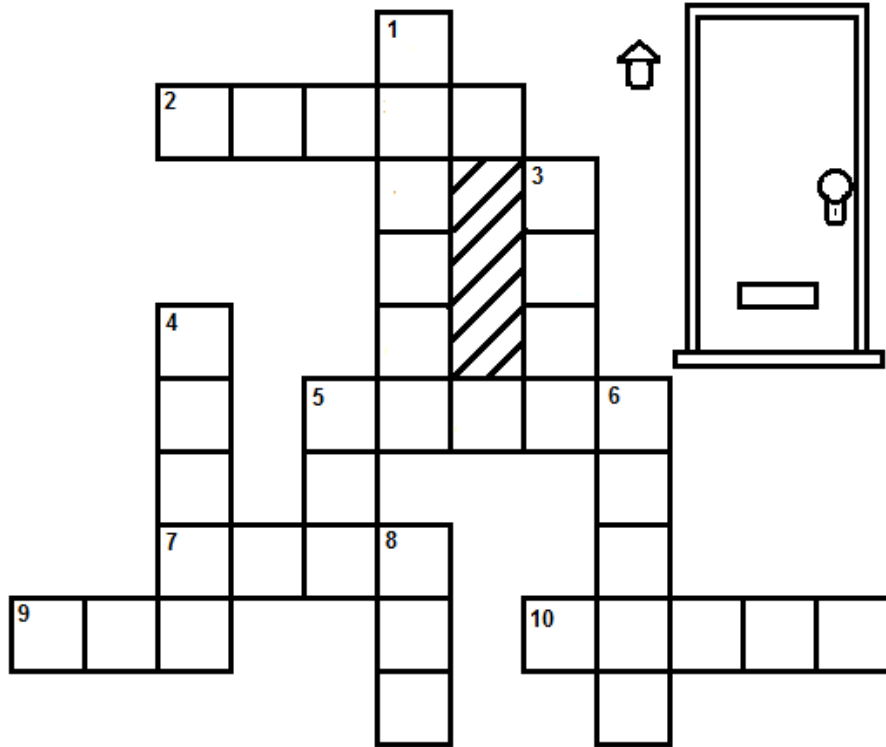

ACROSS

- 2. To give passage
- 5. To be aware of sound
- 7. Approach, arrive
- 9. Behold
- 10. Sharp noise, at the door

DOWN

- 1. For all persons
- 3. Place of admission
- 4. Your own sound
- 5. Person
- 6. Upright, on your feet
- 8. Feast

WORD BANK: See! I stand at the door and knock. If anyone hears my voice and opens the door, I will come in to him and eat with him, and he with me.

Revelation 3:20 CSB©

Let's talk about it. Have you invited Jesus into your life?

THE EXPLORER'S CHALLENGE

Acts 17:11 ERV©

The people in Berea were more open-minded than those in Thessalonica. They were so glad to hear the message Paul told them. They studied the Scriptures every day to make sure that what they heard was really true.

Underline the names.

Circle the words that describe the people of Berea.

Draw a box around what they did.

Draw arrows to the reason why.

Unscramble the verse.

1 Thessalonians 5:18 JKV

In yrthvieneg ivge nathks: ofr sthi is

eth ilwl of oGd in rCshit eJuss

icnceorngn oyu.

Let's talk about it. How can you give thanks for everything, even things that make you sad?

Find the letters B, U, D, D, I, N, and G.



Good people are like **BUDDING** palm trees. They grow strong like the cedar trees of Lebanon. Psalm 92:12 CEV©

Let's talk about it. Why is being a good person worth it?

J	B	E	G	A	N	C	G	W	D
F	C	C	O	R	D	G	O	I	C
W	I	T	H	I	N	D	O	L	E
R	A	N	I	P	D	S	D	L	R
C	E	F	I	N	A	L	L	Y	T
G	H	T	E	S	E	H	Y	J	A
O	E	R	U	I	H	D	F	E	I
D	T	O	I	R	D	E	I	S	N
W	O	R	K	S	N	E	D	U	O
D	A	Y	E	I	T	S	G	S	D

Find the underlined words.

And I am certain that God, who began the good work within you, will continue His work until it is finally finished on the day when Christ Jesus returns. Philippians 1:6 NLT©

Let's talk about it. What work is God doing in your life?

The
LORD
watches
over all
who honor
Him and
trust His
kindness.

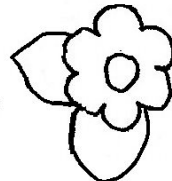
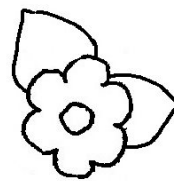
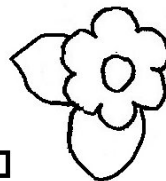
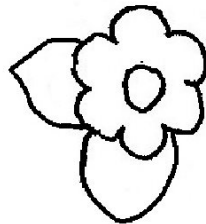

Psalm 33:18 CEV©

Your word is a
lamp to my feet

Psalm 119:105 NIV©

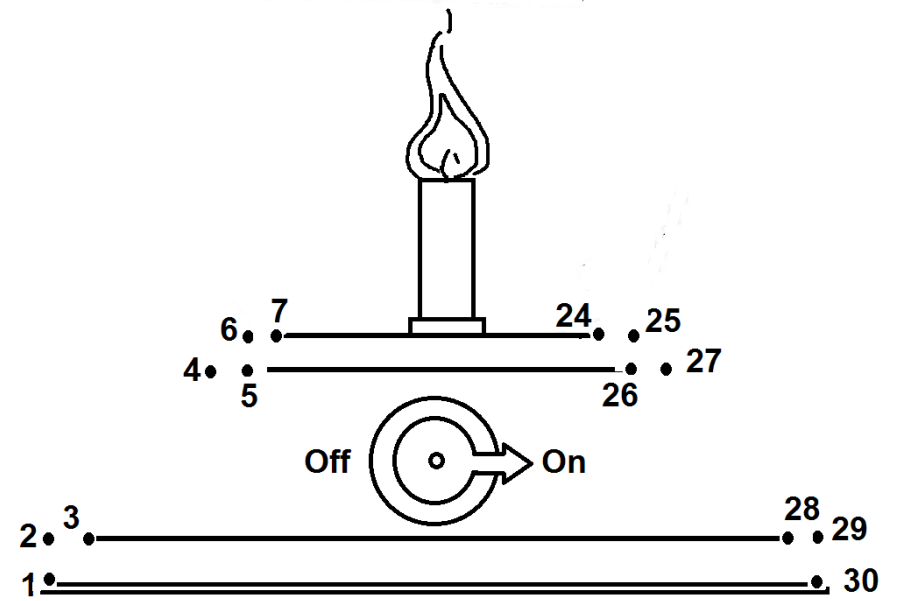
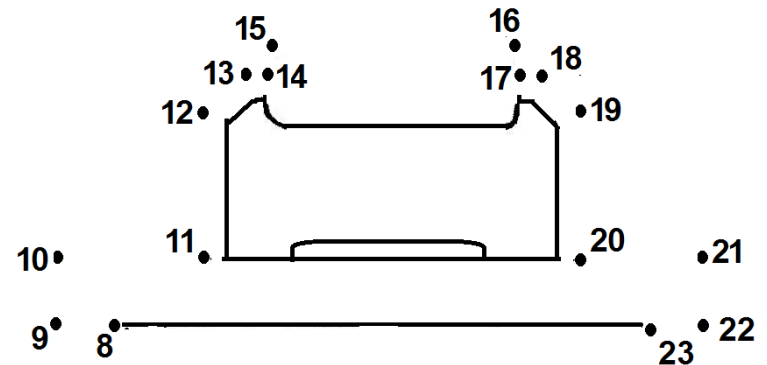

When do you need a lamp? How is God's word like a lamp?

Let's talk about it. How do you honor God?

Subscribe at Patreon.com/aedozat

© A.E. Dozat 2024

Subscribe at Patreon.com/aedozat

© A.E. Dozat 2024

Put the lost words back in their places.

In me →

← light

I have come as _____ into the world

↓

I came so that whoever _____

↑

would _____ in darkness.

↑ believes

not stay →

John 12:46 ICB©

Write the letters in the numbered spaces to read the message.

Do not ¹¹love the world or anything ⁵ that ⁴belongs to the world¹⁴. If you you ¹⁰love the world, you do ¹⁹not love the Father¹⁷. Everything that ⁹belongs to the world⁷—what the sinful¹⁵ self desires²¹, what peo²ple see and want, and e³verything in ¹⁶this world that people ¹³are so prou⁶d of—none of this none of this comes¹² from the Fa⁸ther; ¹⁸it all comes from the worl¹d.

1 John 2:15-16 NIV©

1 2 3 4 5 6 7 8 9 10 11 12

13 14 15 16 17 18 19 20 21

Why is it better to love God more than anything else?

Cut out the Read the Bible Bookmark. Fold it in half. Keep it in your Bible. Mark off the days you read God's Word.

WEEK OF ___/___

Day 1
1 John 1:1 - 2:2

Day 2
1 John 2:7 - 2:27

Day 3
1 John 2:28 - 3:10

Day 4
1 John 3:11- 4:6

Day 5
1 John 4:7- 5:3

Day 6
1 John 5:4 - 21

Day 7
Cach Up Day

Read the Bible Every Day

Ask yourself

Is there a sin to avoid?
Is there an example to follow?
Is there a truth about God?
Is there a lesson to learn?
Is there a warning to heed?
Is there a reason to be thankful?

What is this about?
When is this happening?
Who is this about?
Why does God tell us this?
How can I obey this?

Fill in the blanks and read the verse.

So then f_____ c_____

_____ by _____ g, and

h_____ by the

w_____ of _____ d. Romans 10:17 AKJV©

hearing, word, God, faith, comes, hearing.

How many ways can people hear God's word?

Make a memory verse trading card.

Color the picture, cut out both sides, and glue them back to back. When it is dry, use it to help memorize the Bible verse.

Class: God's Faithfulness

The Lord
won't
leave His
people
nor give
up His
children.

Psalm 94:14