

Circle the difference in each picture. Do you know what Bible person had which dreams?

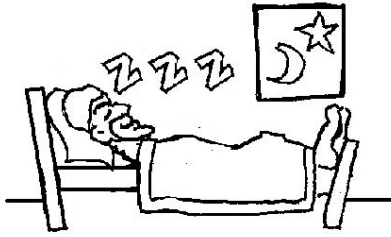

1. In his dream the moon and stars bowed to him.

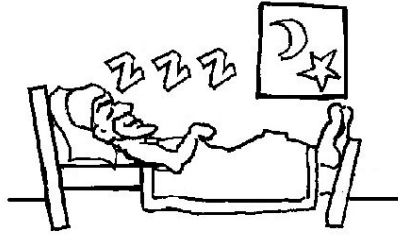

2. In his dream angels went up and down a ladder.

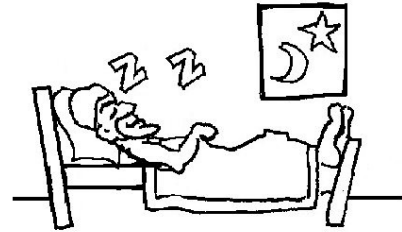

3. He had a dream about cows and stalks of wheat.

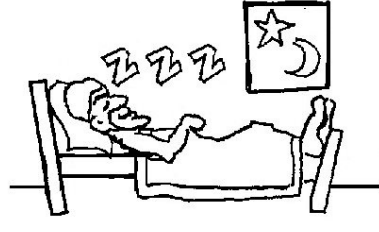

4. In his dream an angel told him to take his family to Egypt.

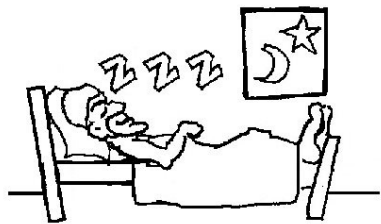

5. In his dream a statue's feet were smashed by a stone.

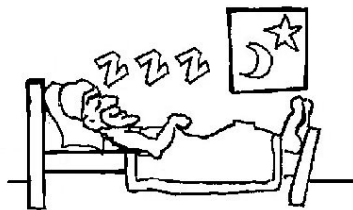

6. She had a bad dream and blamed it on Jesus.

- 1. Joseph, (Genesis 37:7-9)    2. Jacob, (Genesis 28:10, 12)
- 3. Pharaoh, (Genesis 41:1-4)    4. Joseph, (Matthew 2:13)
- 5. Nebuchadnezzar, (Daniel 2:8 34)
- 6. Pilate's Wife, (Matthew 27:19)



For more printable bulletins like this go to [Patreon.com/aedozat](https://Patreon.com/aedozat)

# BIBLE TIME FUN WEEKLY

Issue 231

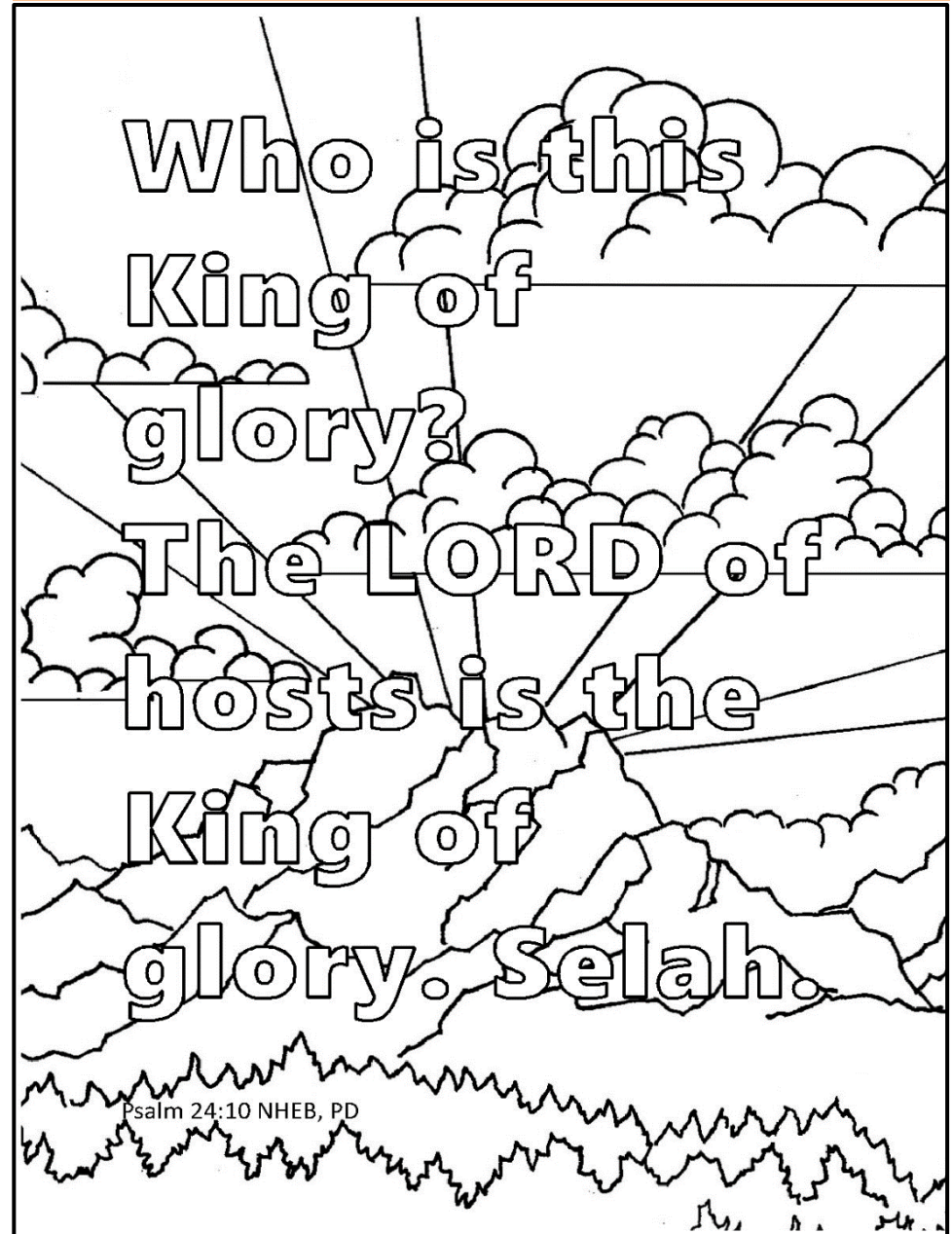

Psalm 24:10 NHEB, PD

Use the clues to find the words from the verse, next group the marked words, and then sort the letters to finish the sentence.

**But you are a chosen race, a royal priesthood, a holy nation, a people for His own possession, that you may proclaim the excellences of Him who called you out of darkness into His marvelous light.**

1 Peter 2:9 ESV©

State, republic, domain \_\_\_\_\_ [ ] \_\_\_\_\_

Gloom, shadows, black \_\_\_\_\_ [ ] \_\_\_\_\_

Human beings, crowd \_\_\_\_\_ [ ] \_\_\_\_\_

Invited, chosen, named \_\_\_\_\_ [ ] \_\_\_\_\_

Picked, selected, elected \_\_\_\_\_ [ ] \_\_\_\_\_

Separated, gone, removed \_\_\_\_\_ [ ] \_\_\_\_\_

Noble, kingly, prince [ ] \_\_\_\_\_

Kindred, tribe, group \_\_\_\_\_ [ ] \_\_\_\_\_

**You are God's**

\_\_\_\_\_

**and in Him you have a purpose.**

Let's talk about it. How many ways are there to proclaim Jesus?

# THE CODE BREAKER

Use the clues to break the code.

↓ ▷ ↓ ↙ ↘ ✕ ▲ ⇒ ↓ ▽ + ▲ ⇅ ▶

↙ ⇅ ▲ □ ▷ ↓ ◀ ↑ ⇒ ↙ ↘ ↘ ▲

↑ + ⇒ ▲ ◀ ⇒ ⇅ □ ◀ + ↙ ↘

⇒ ◊ ⇅ ▶ ◀ ◀ ↑ + ▷ ⇅ ⇅ □ + ▲ ▽

▲ ⇅ ▶ ↑ ⇒ ◈ + ▷ ⇅ ▲ ↗ + □.

**Clues:** □=D, ↑=H, ⇅=O, ▽=S, ▶=U, ▷=W.

Psalm 9:1 CEV©

What does it mean to do something with all your heart?

Contemporary English Version Copyright © 1995 by American Bible Society. Used by Permission.

**Can you read backwards writing?**

**A generous person will prosper; whoever refreshes others will be refreshed.**

Proverbs 11:25 NIV©

Let's talk. How many ways are there to be generous?

E D H T V E R P R G A M C  
 R C P A H N V K H N S U H  
 J B R R E S P E C T K Y R  
 A O E U A E W H R L S O I  
 S P P B R N Y R V Y T U S  
 U Q A K T P S T E K O R T  
 A L R R S A S W S A C N W  
 L O E N T L J N E S S N E  
 W P D L O R D K H R E O R  
 A V R G F P R P O N N A N  
 Y P E O L S Y O P V R S M  
 S R L R E R D S E G I V E

Find the Underlined Words.

But in your hearts set apart Christ as Lord.  
Always be prepared to give an answer to  
everyone who asks you to give the reason  
 for the hope that you have. But do this with  
gentleness and respect,

1 Peter 3:15 NIV©

Let's talk about it. What is the hope that you have?

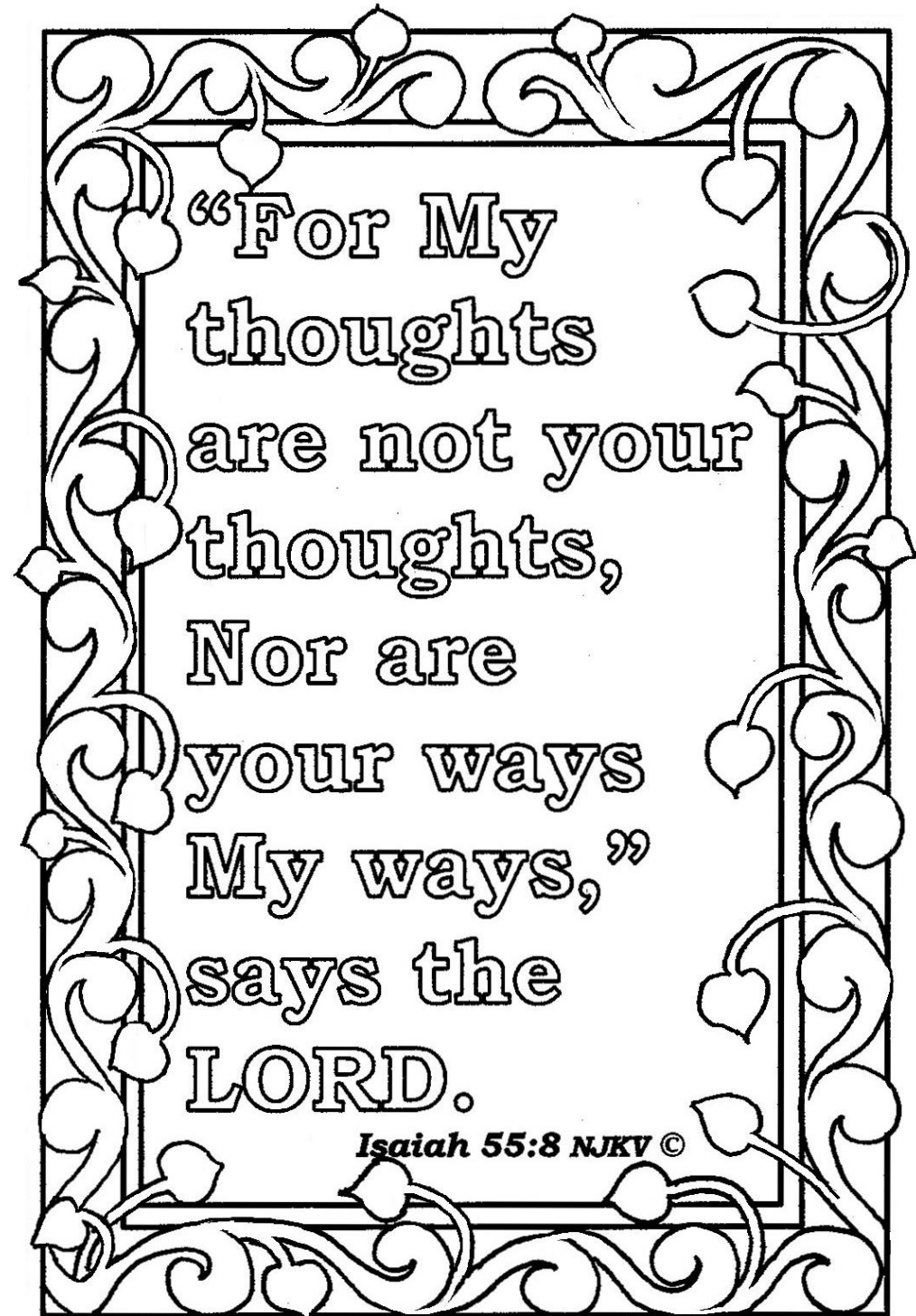

New King James Version, Copyright © 1982 by Thomas Nelson.  
Used by permission. All rights reserved.

©A.E. DOZAT 2023

Use the clues and the word bank to fill in the puzzle.

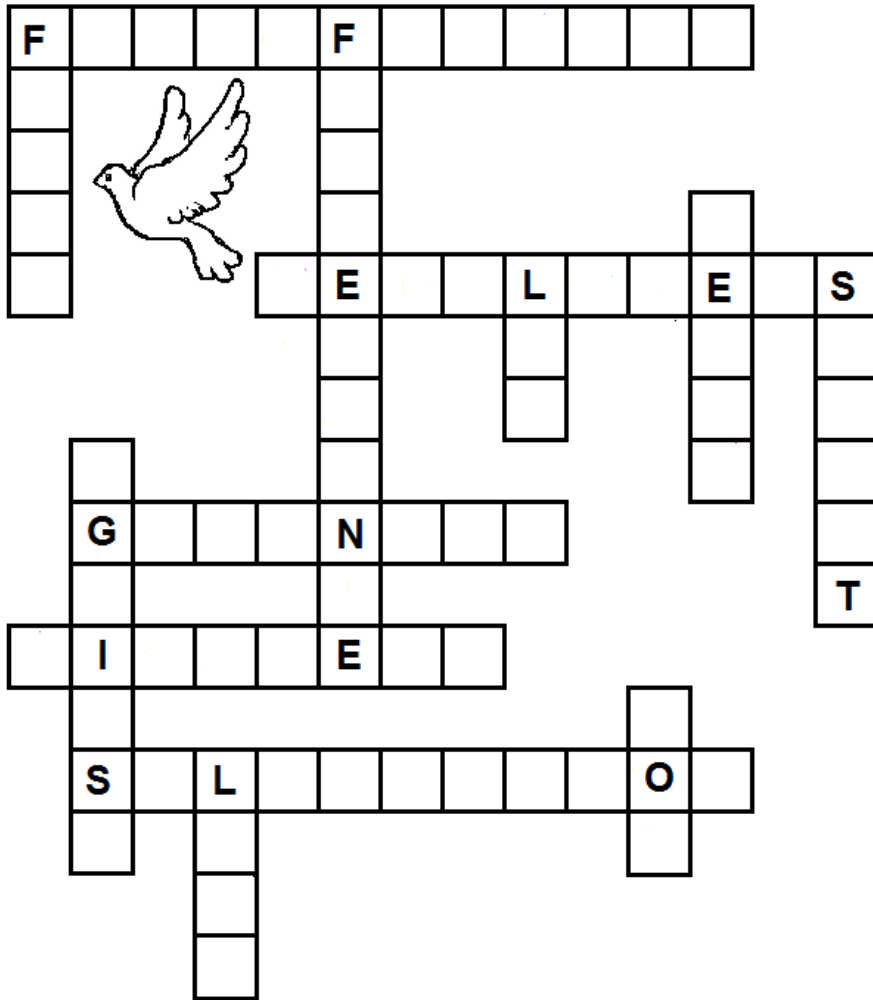

**WORD BANK:** But the fruit of the Spirit is love, joy, peace, forbearance, kindness, goodness, faithfulness, gentleness and self-control. Against such things there is no law. Galatians 5:22-23 NIV©

Let's talk about it. How do you get the fruit of the Spirit?

## THE EXPLORER'S CHALLENGE

Jesus replied: "Love the Lord your God with all your heart and with all your soul and with all your mind.' This is the first and greatest commandment. And the second is like it: 'Love your neighbor as yourself.' All the Law and the Prophets hang on these two commandments."

Matthew 22:37-40 NIV©

Circle all **repeated** words in this verse.  
Underline **each thing** we are to do.  
Draw a box around the **reasons**.

Let's talk about it. What would your life be like if you Loved God with all your heart?

New International Version®, NIV® Copyright © 2011 by Biblica, Inc.® Used by permission. All rights reserved worldwide.

### Unscramble the verse.

Dglieth ofuyresl ni het ORLD; nad eH liwl

eivg oyu het esdisre fo oyur reath

Psalms 37:4 NASB©

Let's talk about it. How can you be delighted in God?

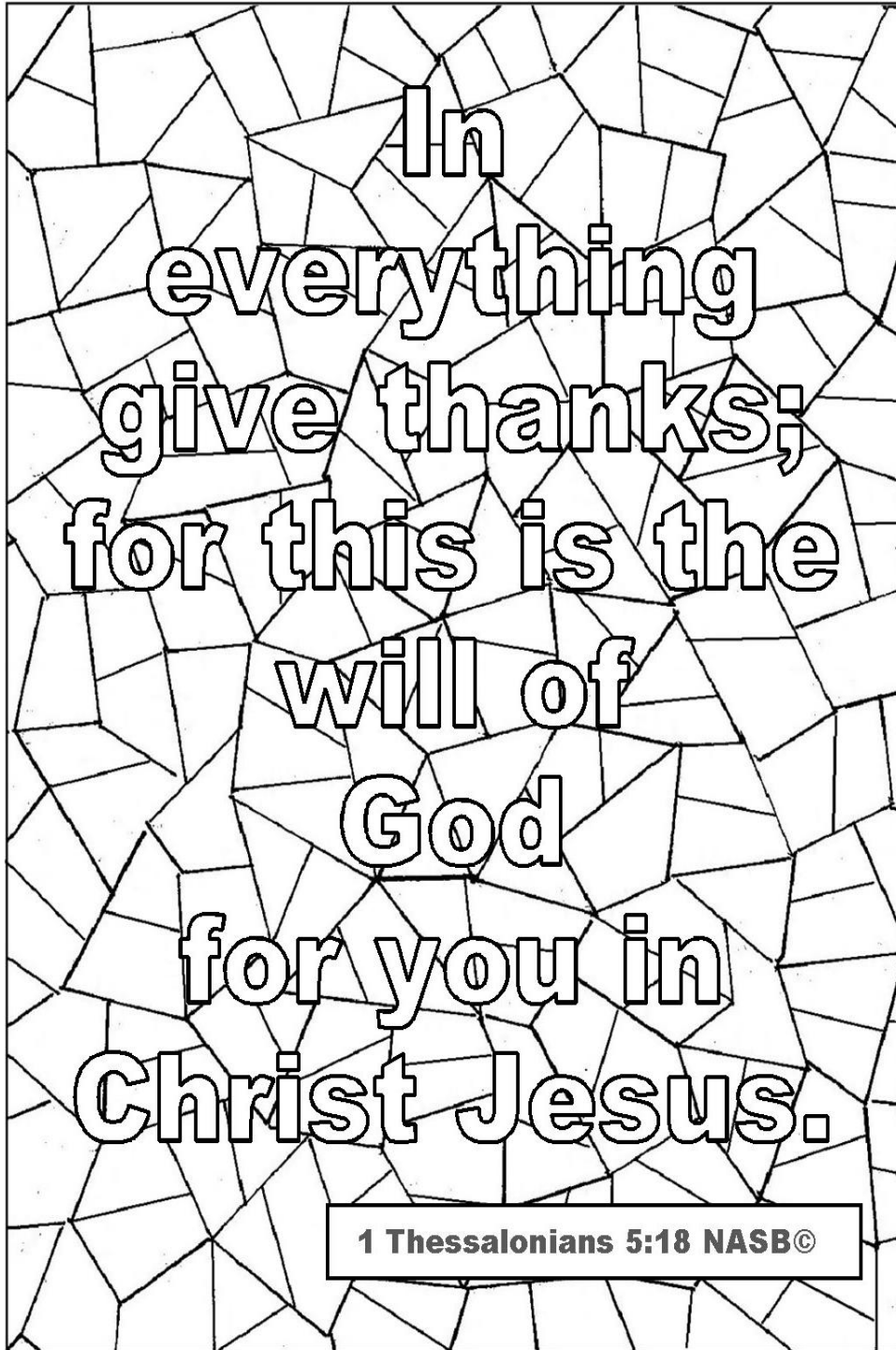

## Trace the letters.

Be careful  
how you  
think  
your life is  
shaped by  
your  
thoughts.

Proverbs 4:23 GNT©



Find the letters “F, I, R, S, T,” and then fill in the spaces.

We love Him, because He FIRST loved us.

John 4:19 KJV, PD

How does God’s love make you want to love Him back?

I	A	E	P	O	W	E	R	N	G
A	L	L	V	W	S	W	I	L	L
K	R	D	B	H	O	N	O	R	K
B	A	E	O	F	L	R	V	I	A
U	E	M	C	R	E	A	T	E	D
E	G	C	K	E	T	N	O	H	P
X	L	B	A	O	I	E	U	L	Y
I	O	S	G	U	D	V	R	O	S
S	R	G	O	D	S	R	E	R	T
T	Y	P	Y	O	U	E	D	D	E

Find the underlined words

Our Lord and God, You are worthy to receive glory and honor and power, because You have created all things, and because of Your will they exist and were created.

Revelation 4:11 HCSB©

Let’s talk about it. How do you honor God?

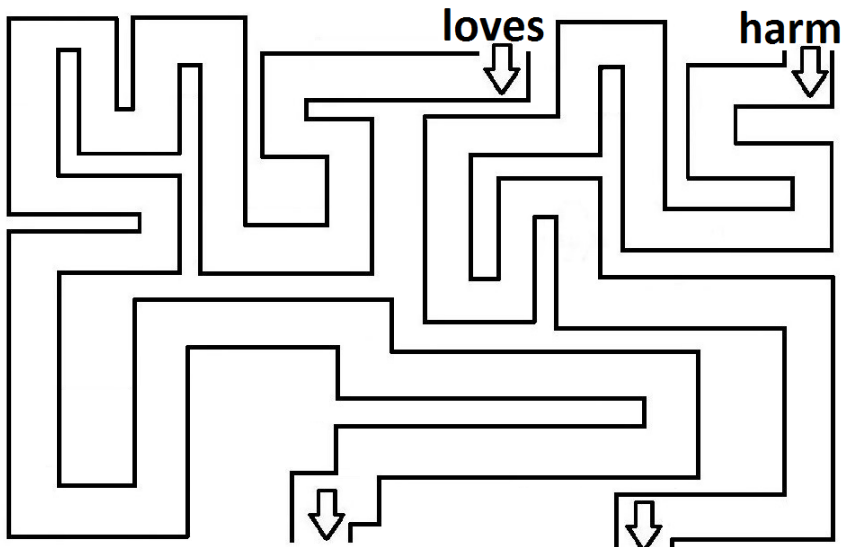

No one who \_\_\_\_\_ others will \_\_\_\_\_ them.

So \_\_\_\_\_ is all that the \_\_\_\_\_ demands.

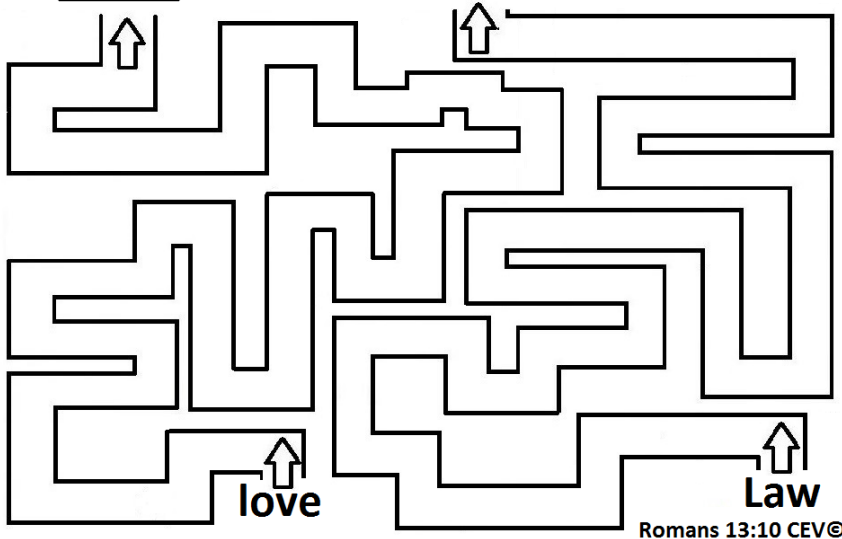

Romans 13:10 CEV©

**Put the lost words back in their places.**

Let's talk about it. Why does love not harm others?

Use the clues to find words from the verse and write them into the grid. Copy the circled letters into the dashes to read the message.

God has chosen you and made you his holy people. He loves you. So your new life should be like this: Show mercy to others. Be kind, humble, gentle, and patient. Don't be angry with each other, but forgive each other. If you feel someone has wronged you, forgive them. Forgive others because the Lord forgave you. Together with these things, the most important part of your new life is to love each other. Love is what holds everything together in perfect unity.

Colossians 3:12-14 ERV©

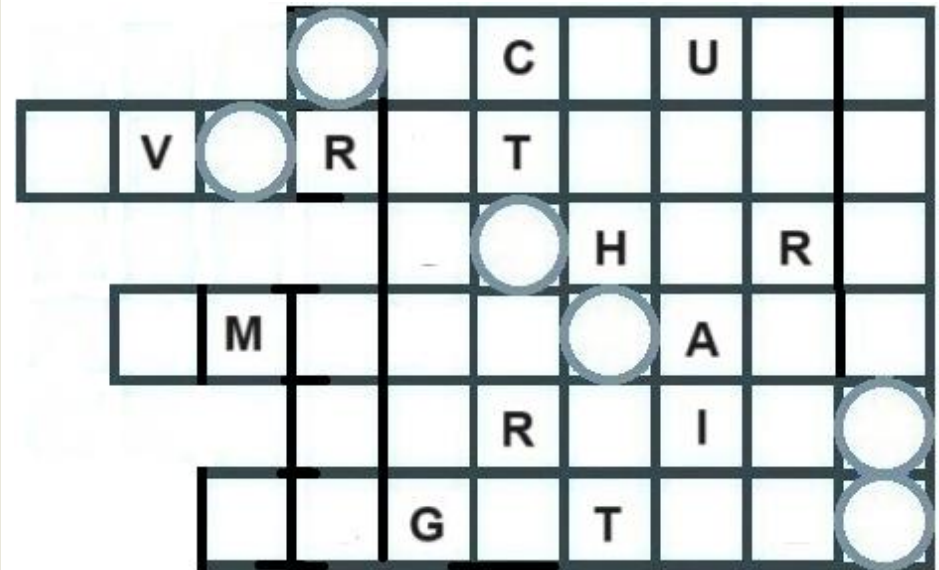

**When you come to Jesus, many things change. One is that you start to become more of a \_\_\_\_\_ person than you ever could be before.**

Cut out the Read the Bible Bookmark. Fold it in half. Keep it in your Bible. Mark off the days you read God’s Word.

WEEK OF \_\_\_/\_\_\_

Day 1

Psalm 46 and 48

Day 2

Psalm 49

Day 3

Psalm 50

Day 4

Psalm 51

Day 5

2 Samuel 1

Day 6

2 Samuel 2 and 3

Day 7

Cach Up Day

Read the Bible Every Day

Ask yourself

Is there a sin to avoid?  
Is there an example to follow?  
Is there a truth about God?  
Is there a lesson to learn?  
Is there a warning to heed?  
Is there a reason to be thankful?

What is this about?  
When is this happening?  
Who is this about?  
Why does God tell us this?  
How can I obey this?

Fill in the blanks and read the verse.

And without f\_\_\_\_\_ it is impossible to p\_\_\_\_\_ Him, for whoever would draw n\_\_\_\_\_ to God m\_\_\_\_\_ believe that he e\_\_\_\_\_ and that He rewards those who s\_\_\_\_\_ Him.

Hebrews 11:6 ESV©

Please, exists, near, seek, faith, must.

Let’s talk about it. How do you get faith?

New Living Translation, copyright © 2015 by Tyndale House Foundation. All rights reserved.

Make a memory verse trading card.

Color the picture, cut both sides out, and glue them back-to-back. When it dries, use it to help memorize the Bible verse.

Class: Wisdom

A gentle answer turns away wrath, but a harsh word stirs up anger.

Proverbs 15:1 NASB ©

Proverbs 15:1 NASB©