

## WHAT THE BIBLE TEACHES

God wants everyone to be saved and to fully understand the truth. There is only one God, and there is only one way that people can reach God. That way is through Christ Jesus, who as a man gave himself to pay for everyone to be free. This is the message that was given to us at just the right time.

1 Timothy 2:4-6 ERV©

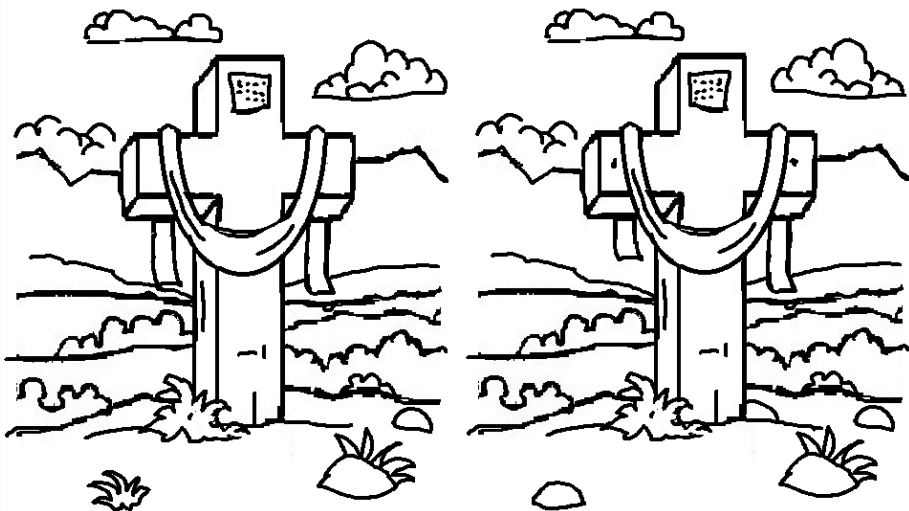

Circle the six differences between the two pictures.

*Let's talk. Why did God do everything that needed to be done for you to go to heaven?*



Scan the QR code to visit the blog. There you can download free issues of BIBLE TIME FUN.

# BIBLE TIME FUN WEEKLY

**A GOSPEL CELEBRATION ISSUE**

Issue 200

The Word became a human being and lived here with us.

John 1:14a CEV©

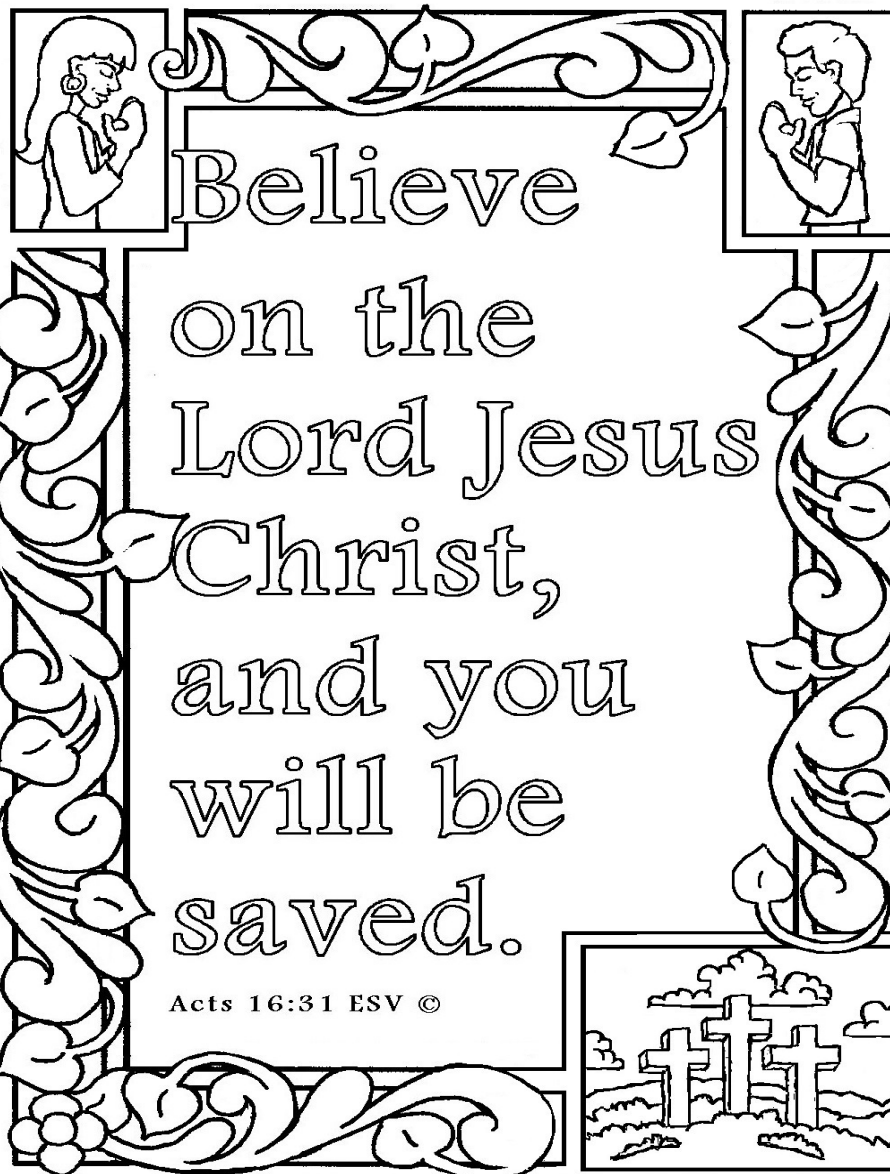

Believe

on the  
Lord Jesus  
Christ,  
and you  
will be  
saved.

Acts 16:31 ESV ©

Use the clues to write the words from the verse in the dashes. Group the clues by shape. Then unscramble the words.

**If you openly declare that Jesus is Lord and believe in your heart that God raised him from the dead, you will be saved. For it is by believing in your heart that you are made right with God, and it is by openly declaring your faith that you are saved.**  
Romans 10:9-10 NLT©

Public, honest, willingly

King, superior, ruler

Rescued, freed, healed

Lifeless, gone, no more

Along, beside, plus

Core, center, soul

Lifted, brought up

Belief, trust, certain

Accept, know, trust

Swear, inform, notify

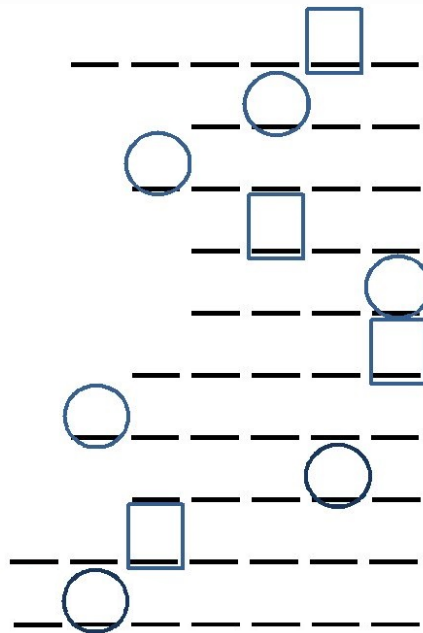

Sort the letters by shapes.

□ \_\_\_\_\_ ○ \_\_\_\_\_

Unscramble the letters.

\_\_\_\_\_

*Let's talk about it. Would you keep the greatest thing that ever happened to you a secret?*

**Use the clues to break the code.**

1 9 , 8 , 1 4 , 1 5 , 1 4 , 1 , 2 3 , 1 0 , 1 8

5 , 3 , 2 6 , " 3 6 , 2 6 1 , 5 , 8 , 1 3 , 6 , 4 ,

1 , 5 , 8 1 , 2 4 , 1 5 , 1 , 5 , 6 , 1 2 , 1 8

1 , 5 , 8 1 0 , 3 , 2 5 , 8 . 1 2 , 2 3 ,

2 3 , 1 2 , 8 , 2 0 , 6 , 1 2 2 0 , 2 3 , 2 6 , 8

1 , 2 3 , 1 , 5 , 8 2 5 , 6 , 1 , 5 , 8 , 2 4

8 , 9 , 2 0 , 8 , 2 , 1 1 , 5 , 2 4 , 2 3 , 1 5 , 1 1 , 5

2 6 , 8 .

John 14:6 NLT©

**Clues: 1=T, 8= E, 10=L, 12=N, 14=S, 24=R.**

*Let's talk about it. Since Jesus is the only way to God, how do you get to God through Jesus?*

NLT Holy Bible, New Living Translation, copyright © All rights reserved.

**Unscramble the verse.**

**Yse, lal avhe nesind; lla flal hsrot fo**

**Gdo's oglrouis diale;**

Romans 3:23 TLB©

R Y I N C T M I G H T V L  
 L I N I S B E E N D P W P  
 W S G M K U H C A Y F O H  
 D O Q H R L C E R U A U R  
 L H U E T S R H Y O C N I  
 C I B A I E N Q R A S D C  
 H M S L L F O A O I R S T  
 A S N E U I A U N G S C H  
 V E W D S A V L S N K T N  
 E L U R S T U E H N D I E  
 H F K O M C A R R I E D T  
 R T M W U S I N S D W S G  
 W B O D Y R S E Y P L N S

Find the underlined words

Christ himself carried our sins in his body to the cross, so that we might die to sin and live for righteousness. It is by his wounds that you have been healed.

1 Peter 2:24 GNT©

*Let's talk about it. Since Jesus died for you, isn't there something you should do for him?*

Christ  
 died for  
 our sins  
 according  
 to the  
 Scriptures

1 Corinthians 15:3b NIV©

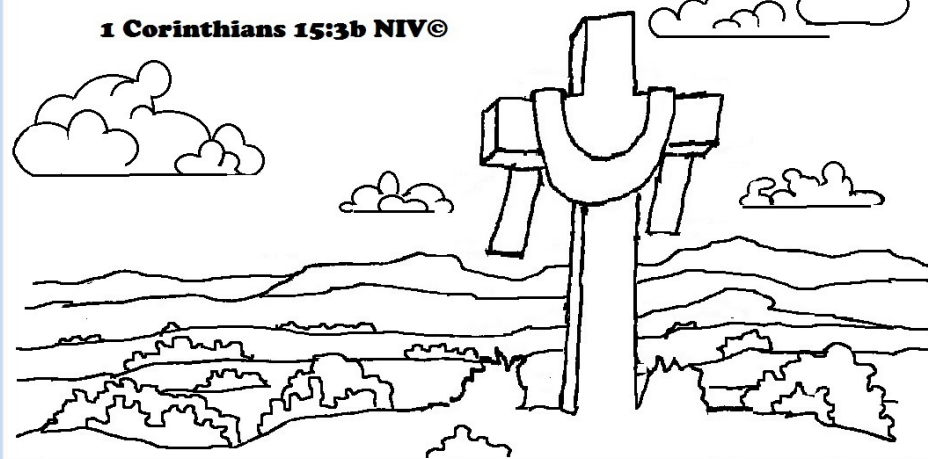

*Did God always plan to send His Son to die for you?*

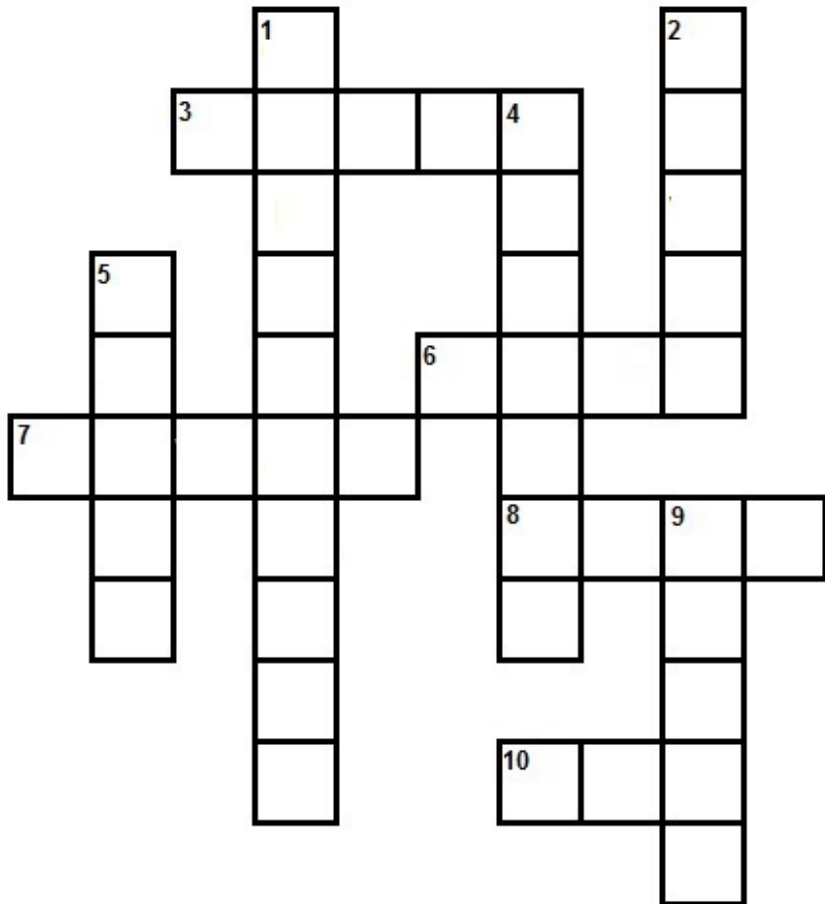

**ACROSS**

- 3. To brag
- 6. Possession of the Lord
- 7. No longer in danger
- 8. A present
- 10. Opposite of approve

**DOWN**

- 1. People personally
- 2. To earn just do these
- 4. The way you enter
- 5. God's kind favor
- 9. To believe

**WORD BANK:** For you are saved by grace through faith, and this is not from yourselves; it is God's gift not from works, so that no one can boast.

Ephesians 2:8-9 HCSB©

*Let's talk about it. When does a gift become yours?*

**The Explorer's Challenge**

Matthew 11:28 ICB©

**Come to me, all of you who are tired and have heavy loads. I will give you rest.**

Draw a box around words that tell who. Underline what Jesus asks us to do. Circle the word that tells what Jesus will give. Draw an arrow to the words of his promise.

*Let's talk about it. What heavy loads do you have? What kind of rest do you need?*

International Children's Bible®, copyright ©1986, 1988, 1999, 2015 by Tommy Nelson. Used by permission.

**Unscramble the Verse**

1 John 5:12 ESV©

**hWorvee ahs eth nSo ash efil;  
oewwher sedo tno vahe eth nSo fo  
dGo edso nto ahve elfi.**

*Let's talk about it. What does it mean to have the Son?*

English Standard Version® (ESV®) Copyright © 2001 by Crossway, a publishing ministry of Good News Publishers. All rights reserved.

**Read the verse in a mirror.**

**deserveb ©VEV 3:8 CEV LORD gave him the punishment we off. We had each gone our own way, but the All of us were like sheep that had wandered**

Find the letters R, E, C, E, I, V, E, and color the word.



But to all who did **RECEIVE** him, who believed in his name, he gave the right to become children of God. John 1:12 ESV©

*Let's talk about it. How does a person receive something?*

H	E	B	T	W	O	R	L	D	G
G	O	D	E	K	P	W	R	L	P
E	M	O	W	L	O	H	V	S	E
N	T	F	N	J	I	O	L	O	R
L	O	E	H	L	R	E	Y	N	I
G	L	T	R	D	Y	V	V	B	S
V	A	J	R	N	U	E	U	E	H
H	D	V	S	L	A	R	V	N	S
L	O	V	E	D	V	L	Y	C	R
O	N	E	G	K	L	I	F	E	E

Find the underlined words.

For God so loved the world that He gave His one and only Son, that whoever believes in him shall not perish but have eternal life.

John 3:16 NIV©

*Let's talk about it. What does it mean to believe?*

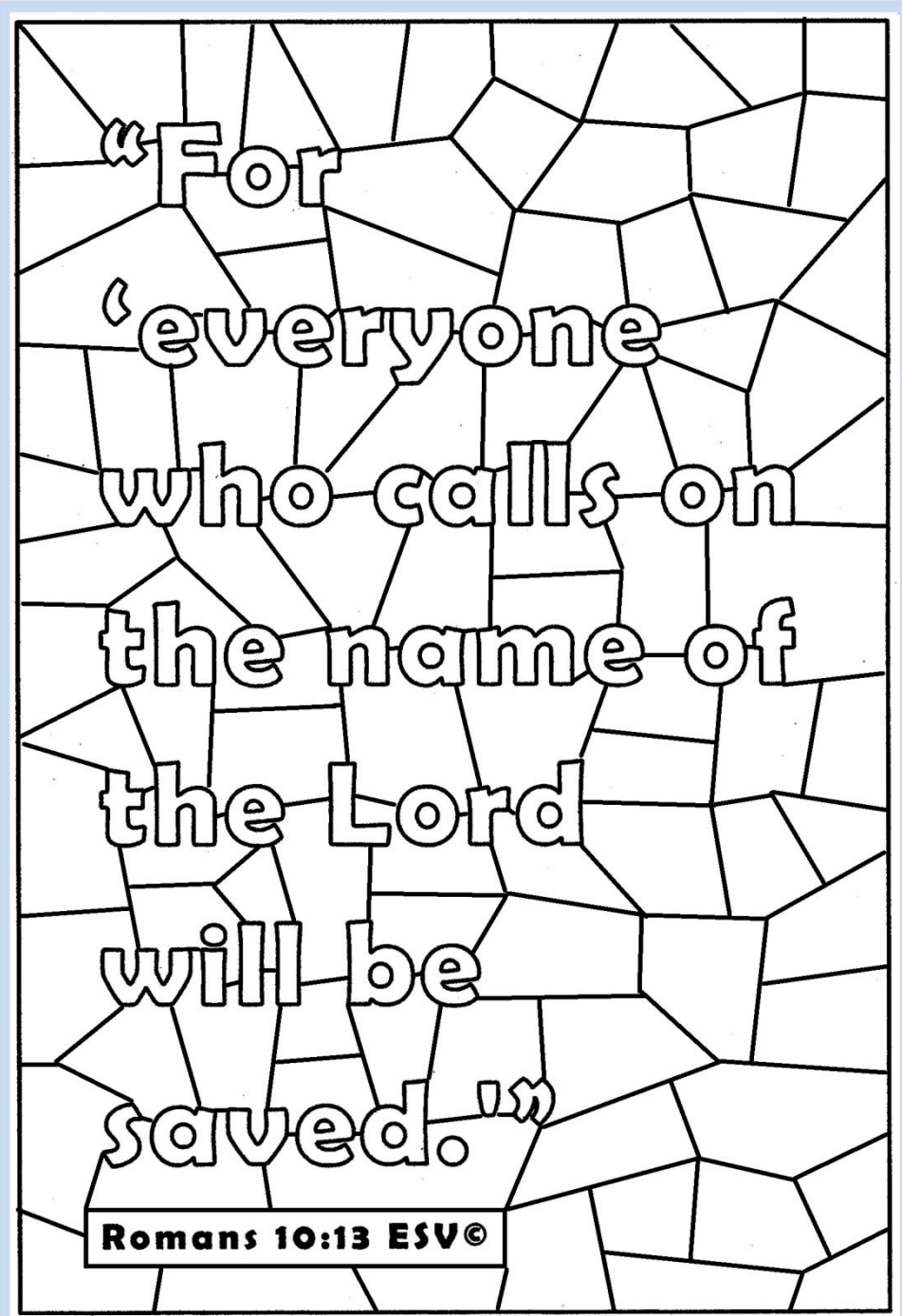

*Let's talk about it. Have you ever called out to God?*

For the  
Son of  
Man came  
to seek  
and to  
save the  
lost.

Luke 19:10 ESV©

*Let's talk about it. Why does the Bible teach we are lost until we come to Jesus?*

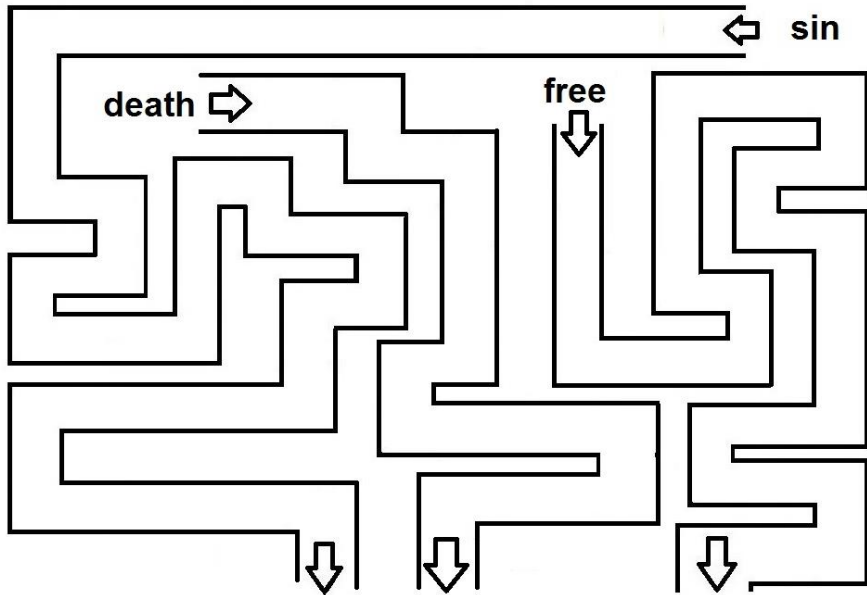

For the wages of \_\_\_\_\_ is \_\_\_\_\_, but the \_\_\_\_\_ gift of God is eternal \_\_\_\_\_ through \_\_\_\_\_ our Lord.

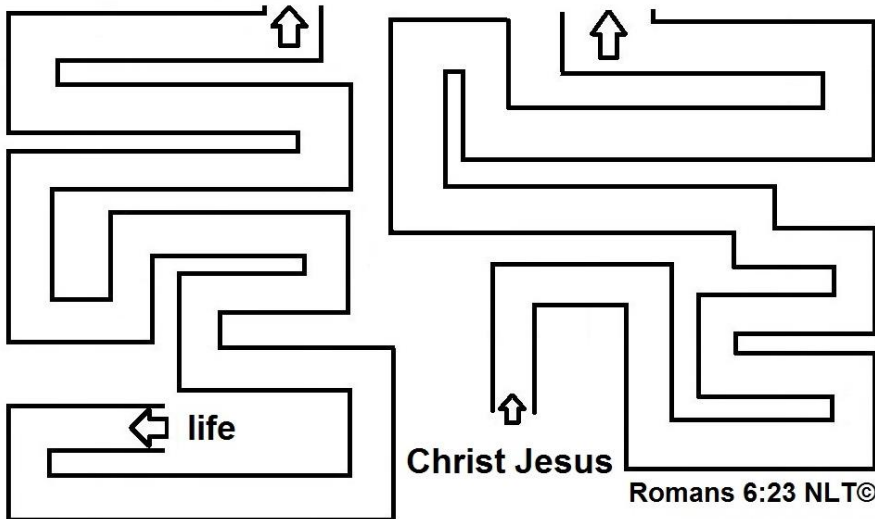

Christ Jesus  
Romans 6:23 NLT©

*Let's talk about it. Why does God make eternal life a gift?*

Use the clue letters to find the words from the verse and write them into the grid. Copy the circled letters into the dashes to finish the message.

**Christ suffered for our sins once for all time. He never sinned, but he died for sinners to bring you safely home to God. He suffered physical death, but he was raised to life in the Spirit.**

1 Peter 3:18 NLT©

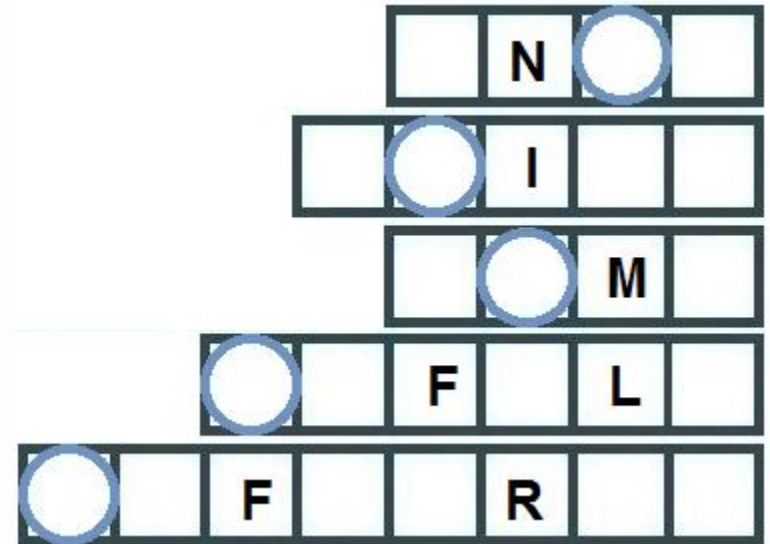

**Jesus took the punishment for your sins when he died on the**

\_\_\_\_\_.

*Let's talk about it. Since Jesus took the punishment for your sins do you need to make up for them?*

Cut out the Bible reading Bookmark, and fold in half. Put it in your Bible and mark the days as you read God's Holy Word.

Week of \_\_\_/\_\_\_

Day 1  
Leviticus 21 and 22

Day 2  
Leviticus 23

Day 3  
Leviticus 24

Day 4  
Leviticus 25

Day 5  
Leviticus 26

Day 6  
Leviticus 27

Day 7  
Catch up day  
Read the Bible every day.

**Ask yourself**

Is there a sin to avoid?  
Is there an example to follow?  
Is there a truth about God?  
Is there a lesson to learn?  
Is there a warning to heed?  
Is there a reason to be thankful?

What is this about?  
When is this happening?  
Who is this about?  
Why does God tell us this?  
How can I obey this?

**Fill in the blanks and read the verse.**

But **G**\_\_\_ **p**\_\_\_\_\_ **His** **o**\_\_\_

**I** \_\_\_\_\_ **for us in that w**\_\_\_\_\_ **we**

**were s**\_\_\_\_\_ **s**\_\_\_\_\_ ,

**C**\_\_\_\_\_ **d**\_\_\_\_\_ **for us.**

**Word bank: Christ, sinners, love, died, while, still, God, proves, own.**  
Romans 5:8 CSB©

*Let's talk about it. If Christ died for us even though we are sinners, do we need to do something for God to love us?*

The Christian Standard Bible. Copyright © 2017 by Holman Bible Publishers. Used by permission. All rights reserved.

**Make a memory verse trading card.**

Color the picture, cut out both sides, and glue them back to back. When it is dry, use it to help memorize the Bible verse.

**Class: What is sin?**

**Remember,**  
it is sin to  
know what  
you ought  
to do and  
then not do  
it.

**James 4:17 NLT©**